











# 120cm Double Electric Ovens & 5 Burner with Simmer Plate Cooktop

## PSN120SMP



-   
**MADE IN ITALY**
-   
**24 MONTH WARRANTY**
-   
**120CM WIDE**
-   
**EXPERT MODE**
-   
**COOL TOUCH**
-   
**1,625 RAL COLOURS**  
\* consult with ILVE
-   
**88:88<sup>mm</sup>**  
**DIGITAL DISPLAY**
-   
**11 MULTI-FUNCTION MODES**  
\* Main Oven Only
-   
**BRASS BURNER**
-   
**COOKING LEVELS**



Universally considered one of the finest European specialist manufactures of hand crafted cooking appliances, ILVE's Nostalgie range of freestanding ovens does not disappoint.

ILVE Nostalgie ovens offer attractive and traditional country style finishes that enhance the appearance of a traditional kitchen. Combining the perfect synergy of cosmetic and performance excellence, available in 8 colour choices to complement the brass, chrome or bronze control knobs and oven door handles to finish off this truly unique style oven.

ILVE's Nostalgie range is available in 60cm, 70cm, 80cm, 90cm, 100cm, 120cm and 150cm sizes and offers a unique choice of baking, grilling or rotisserie in a single oven or two ovens simultaneously. All models offer the superb quality of features and functions synonymous with ILVE.

These innovative ovens incorporate chef quality features that will delight the foodie at heart who just loves to cook. Across the range, features include 10 or 11 multifunction cooking, 70 to 110 litre oven capacity, electric rotisserie, precision thermostat control and concealed grill element. Turbowave cooking technology which cooks food at lower temperatures for less food shrinkage and splatter that adds satisfaction to every cooking masterpiece.

Further features such as cool touch handle, removable door and dismountable inner glass, self cleaning catalytic liners and panels and triple glazed door add ease of use and safety to the already impressive professional cooking functions.

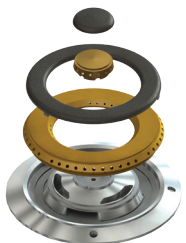

Pictured: ILVE Brass Burner

18112016

### Fitting

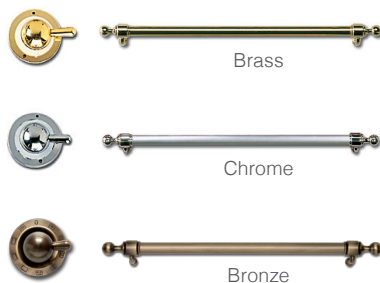

### Colour Palette



# 120cm Double Electric Ovens & 5 Burner with Simmer Plate Cooktop

## PSN120SMP

LIVE WITH  
**ILVE**

### Model PSN120SMP

#### Electric Oven

- Two Electric Ovens: Select 11+5 multifunction cooking modes
- 90 litre oven capacity oven 1
- 50 litre oven capacity oven 2
- Easy clean vitreous enamel interior finished in smooth black
- Electric Rotisserie in both Ovens
- AS304 stainless steel commercial style control panel and knobs
- Dual Recessed full width grill element
- Digital programmable timer (main oven ONLY)
- Control panel and door cooling fan
- Triple glazed glass door for safer, cooler door temperatures
- Catalytic self cleaning system (main oven ONLY)
- Positive stop glide internal trays
- Large baking trays
- Stainless steel fan fat filter (main oven ONLY)
- Removable oven door and inner door glass
- Storage drawer
- Sealed oven: lower temperatures, less food spatter, moister fresher tasting roasts
- Precisionthermostaticcontrol 0°C–250°C
- New Turbowave Quickstart preheating function 0°C –175°C in 7 minutes (main oven ONLY)



For installation specifications, please consult with ILVE. For optimum installation, we recommend using the actual product as the best guide.

#### Gas Cooktop

- 120cm gas cooktop
- Large cooking surface with spacious burner layout
- ILVE's cast iron Simmer Plate / Targa Top surface
- Triple ring solid brass WOK burner (5 kW – European Tested)
- 1 small, 1 elongated/fish and 2 Large gas burners
- Precision burner controls with accurate flame control
- Cast iron heavy duty trivets and burners in matt black finish
- All gas burners fitted with flame failure safety devices
- Deep recessed spill trays
- Easy clean removable trivets and burners
- All burners made from Solid Brass
- AS 304 Stainless Steel construction

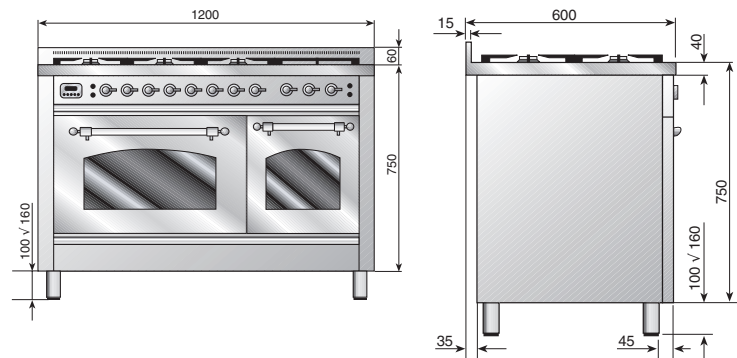

#### 120cm Nostalgie 5 Burner + Simmer Model PSN120SMP

Total Electrical Load (Kw) 5.7

Total Gas 'NG' Consumption (Mj/h) 62.5

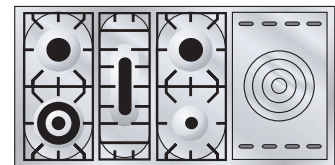

18112016

Australia National Telephone Number 1300 MYILVE (694 583) New Zealand Telephone Number 0508 458 369  
ILVE showrooms are open Tuesday - Friday from 9am-5pm and Saturdays 10am-4pm. CLOSED Monday & Sunday

[ilve.com.au](http://ilve.com.au)

#### NSW & ACT (Head Office)

48-50 Moore Street  
Leichhardt  
F 02 8569 4699

#### VIC & SA

1211 Toorak Road  
Camberwell  
F 03 9809 2155

#### QLD

1/42 Cavendish Road  
Coorparoo  
F 07 3397 0850

#### WA & NT

Unit 10/55 Howe Street  
Osborne Park  
F 08 9201 9188

#### TAS (Crisp Ikin)

3 Pear Avenue  
Derwent Park, 7009  
P 03 6272 7386

#### New Zealand

PO Box 11.160  
Sockburn Christchurch  
F 03 344 5906

#### DISCLAIMER

Eurolinx PTY LTD, trading as ILVE Appliances, is continually seeking ways to improve the design specifications, aesthetics and production techniques of its products. As a result alterations to our products and designs take place continually. Whilst every effort is made to produce information and literature that is up to date, this brochure should not be regarded as an infallible guide to the current specifications, nor does it constitute an offer for the sale of any particular product. Product dimensions indicated in our literature is indicative only. Actual product only should be used to define dimension cutouts. Distributors, and retailers are not agents of ILVE Appliances and are not authorized to bind ILVE Appliances by any express or implied undertaking or representation.