







90cm Induction Cooktop

ILD9E

- 
TOUCH CONTROL
- 
24 MONTH WARRANTY
- 
90CM WIDE
- 
DIGITAL DISPLAY
- 
EXPERT MODE
- 
AUTO STOP
- 
STOP & GO



ILVE's induction cooktops are for people who have been thinking about upgrading their cooktop at home but aren't able to go gas, ILVE's induction systems are the ultimate alternative.

Unlike normal electric cooktops, induction technology produces heat by creating a magnetic field which generates heat directly to the cooking vessel. This means that the heat is instantaneous, temperature control is immediate and the heat is evenly spread over the bottom of the pan, meaning no more annoying hot or cold spots, the ILVE induction elements also include booster zones to minimize heat up times even further.



05032019

Pictured: • 948SXMP Oven
• ILD9E Cooktop
• SIGMA Hood

90cm Induction Cooktop

ILD9E

Model ILD9E - 90cm Induction Cooktop

FEATURE

- Central control panel
- cooking levels 0-9
- Simultaneous timers for each zone
- Independent egg timer
- Personalised presets with cooking level
- Pause mode
- Recall mode
- Automated keep warm option at 70°C

CLEANING & ACCESSORIES

- Easy clean ceran glass surface

ZONES

- 5 cooking zones (see diagram for power statistics)
- 5 Zone Boost, 2 double boost & NEW Start-up Boost on all zones
- Zone bridging mode

SAFETY

- Child lock
- residual heat indicator
- Overflow detection
- Time limitation system according to heat level assisting the cooktop to not overheat
- Long-life protection - protects the electronics against overheating

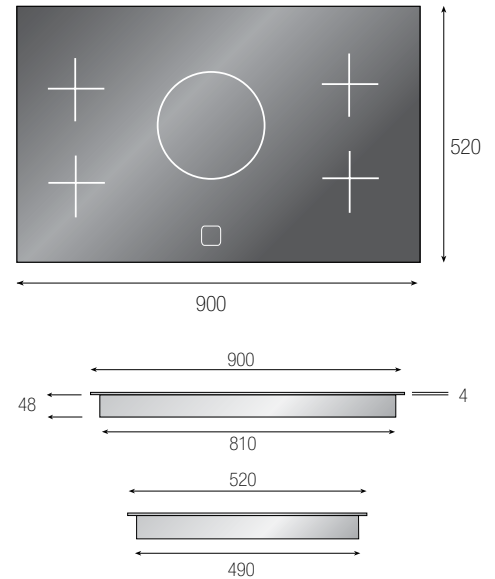

Model ILD9E Induction Hob Casing

Cut out (LxD) : 810 x 490mm – thickness : 53 mm + 4mm glass

Dimensions: 900x520mm, R=5

Electrical network 220-240 V, 50/60 Hz

Total Electrical Consumption: 7400W

Power cord not included

Single phase or two phase

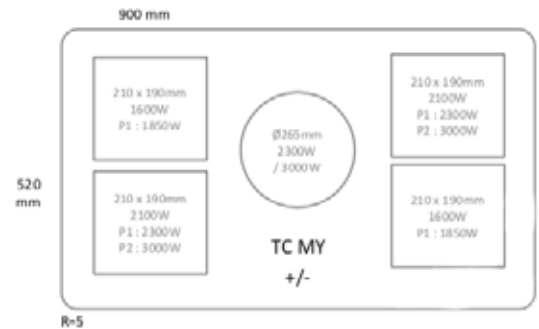

05032019



For installation specifications, please consult with ILVE. For optimum installation, we recommend using the actual product as the best guide.

FOLLOW US ON:



facebook.com/ILVEappliances



instagram.com/ILVE_appliances



youtube.com/ILVEappliances



BLOG livewithilve.com

Australia National Telephone Number 1300 MYILVE (694 583) New Zealand Telephone Number 64 3 344 5913

ILVE showroom hours: Tuesday to Friday - 9am-5pm, Saturday - 10am-4pm, Sunday and Monday - closed

* Melbourne showroom hours: Tuesday to Saturday - 10am-4pm

ilve.com.au

NSW & ACT (Head Office)

48-50 Moore Street
Leichhardt
F 02 8569 4699

VIC & SA

1211 Toorak Road
Camberwell
F 03 9809 2155

QLD

1/42 Cavendish Road
Coorparoo
F 07 3397 0850

WA & NT

Unit 10/55 Howe Street
Osborne Park
F 08 9201 9188

TAS

3 Pear Avenue
Derwent Park
P 03 6272 7386

New Zealand

PO Box 11.160
Sockburn Christchurch
F 03 344 5906

DISCLAIMER

Eurolinx PTY LTD, trading as ILVE Appliances, is continually seeking ways to improve the design specifications, aesthetics and production techniques of its products. As a result alterations to our products and designs take place continually. Whilst every effort is made to produce information and literature that is up to date, this brochure should not be regarded as an infallible guide to the current specifications, nor does it constitute an offer for the sale of any particular product. Product dimensions indicated in our literature is indicative only. Actual product only should be used to define dimension cutouts. Distributors, and retailers are not agents of ILVE Appliances and are not authorized to bind ILVE Appliances by any express or implied undertaking or representation.